



YASKAWA

YASKAWA AC Drive-J1000 Option

# Potentiometer Technical Manual

Type AI-V3/J

To properly use the product, read this manual thoroughly and retain for easy reference, inspection, and maintenance. Ensure the end user receives this manual.

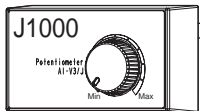

MANUAL NO. TOBP C730600 34A

---

Copyright © 2008 YASKAWA ELECTRIC CORPORATION

All rights reserved. No part of this publication may be reproduced, stored in a retrieval system, or transmitted, in any form or by any means, mechanical, electronic, photocopying, recording, or otherwise, without the prior written permission of Yaskawa. No patent liability is assumed with respect to the use of the information contained herein. Moreover, because Yaskawa is constantly striving to improve its high-quality products, the information contained in this manual is subject to change without notice. Every precaution has been taken in the preparation of this manual. Yaskawa assumes no responsibility for errors or omissions. Neither is any liability assumed for damages resulting from the use of the information contained in this publication.



# Contents

---

<b>1 PREFACE AND SAFETY</b>	<b>4</b>
<b>2 RECEIVING</b>	<b>8</b>
<b>3 PRODUCT OVERVIEW</b>	<b>9</b>
<b>4 OPTION COMPONENTS</b>	<b>10</b>
<b>5 INSTALLATION PROCEDURE</b>	<b>11</b>
<b>6 OPERATING INSTRUCTIONS</b>	<b>14</b>
<b>7 RELATED DRIVE PARAMETERS</b>	<b>15</b>
<b>8 TROUBLESHOOTING</b>	<b>16</b>
<b>9 OPTION SPECIFICATIONS</b>	<b>17</b>
<b>10 YASKAWA LOCATIONS</b>	<b>18</b>
<b>11 REVISION HISTORY</b>	<b>19</b>

# 1 Preface and Safety

## 1 Preface and Safety

### ◆ Applicable Documentation

The following manuals are available for the Potentiometer Option:

#### Option Unit

Option Unit	
	<b>Yaskawa AC Drive - Potentiometer Option Technical Manual</b>  Read this manual first. The Technical Manual is packaged with the Potentiometer Option and contains a basic overview of wiring, settings, functions, and fault diagnoses.

# 1 Preface and Safety

## Yaskawa Drive

	<p><b>U.S., Europe:</b> Yaskawa AC Drive- J1000 Quick Start Guide</p> <p><b>Other areas:</b> Yaskawa AC Drive- J1000 Installation &amp; Start up Manual</p>	<p>To obtain instruction manuals for Yaskawa products access these sites:</p> <p><b>U.S.:</b> <a href="http://www.yaskawa.com">http:// www.yaskawa.com</a></p> <p><b>Europe:</b> <a href="http://www.yaskawa.eu.com">http:// www.yaskawa.eu.com</a></p> <p><b>Japan:</b> <a href="http://www.e-mechatronics.com">http://www.e- mechatronics.com</a></p> <p><b>Other areas:</b> Contact a Yaskawa representative. For questions, contact the local Yaskawa sales office or the nearest Yaskawa representative.</p>
	<p>Yaskawa AC Drive- J1000 Technical Manual</p>	

## ◆ Terms

**Note:** Indicates a supplement or precaution that does not cause drive damage.

**Drive:** Yaskawa AC Drive -J1000 Series

**Option:** Yaskawa AC Drive -J1000 Potentiometer Option

# 1 Preface and Safety

---

## ◆ Registered Trademarks

Company names and product names listed in this manual are registered trademarks of those companies.

---

## ◆ Supplemental Safety Information

Read and understand this manual before installing, operating, or servicing this option unit. The option unit must be installed according to this manual and local codes.

The following conventions are used to indicate safety messages in this manual. Failure to heed these messages could result in serious or possibly even fatal injury or damage to the products or to related equipment and systems.

### **DANGER**

**Indicates a hazardous situation, which, if not avoided, will result in death or serious injury.**

### **WARNING**

**Indicates a hazardous situation, which, if not avoided, could result in death or serious injury.**

# 1 Preface and Safety

---



## CAUTION

Indicates a hazardous situation, which, if not avoided, could result in minor or moderate injury.

## NOTICE

Indicates an equipment damage message.

## 2 Receiving

---

## 2 Receiving

---

### ◆ Receiving

Confirm the packaging after receiving the Potentiometer Option. If the wrong model is received or the Potentiometer Option does not function properly, contact your supplier.

Components packaged with the option:

- The Potentiometer Option (AI-V3/J)
  - Technical Manual
- 

### ◆ Tool Requirements

Use a flat-blade screwdriver with the dimensions below for installation or removal of the option cover and Potentiometer Option.

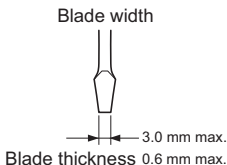



# 3 Product Overview

### ◆ About Product

The Potentiometer Option allows the user to adjust the frequency reference by rotating a potentiometer dial. Turning the potentiometer changes the frequency reference making it easier to adjust the motor speed.

### ◆ Applicable Models

Potentiometer Option can be used with these Yaskawa drive models.

Drive	Drive Software Version <1>
CIMR-J□□A□□□□BA□	≥1010

<1> See “PRG” on the drive nameplate for software version number.

## 4 Option Components

# 4 Option Components

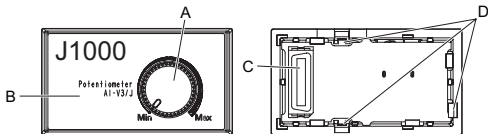

**A – Potentiometer  
Dial**

**B – Option Model  
Number**

**C – Drive  
Connector**

**D – Connection  
Tabs**

## ◆ Dimensions

The installed option adds 21 mm (0.83 in) to the total depth of the drive.

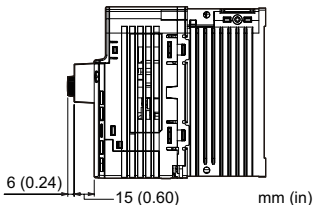

# 5 Installation Procedure

### ◆ Section Safety

#### DANGER

#### **Electrical Shock Hazard**

**Disconnect all power to the drive, before servicing.**

Failure to comply will result in death or serious injury.

Wait at least one minute after all indicators are off. The drive has internal capacitors that remain charged even after the option is disconnected. The drive charge LED will extinguish when the DC bus voltage is below 50Vdc. Measure drive DC bus voltage to confirm safe level.

#### NOTICE

#### **Damage to Equipment**

**Properly connect the connectors.**

Failure to comply may prevent proper operation and possibly damage equipment.

## 5 Installation Procedure

### ◆ Attaching the Option

1. Insert a flat-blade screwdriver into the opening as shown in the diagram below to remove the option cover from the drive.
2. Insert the connector on the back of the option into the CN5 port on the drive, and click it into place.

**NOTICE:** *Damage to equipment. Make necessary parameter adjustments after installing the Potentiometer Option. Failing to follow these installation instructions may damage the drive.*

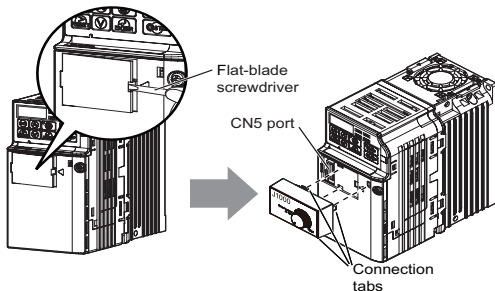

## 5 Installation Procedure

### ◆ Removing the option interface

1. Insert a flat-blade screwdriver into the small opening between the drive and the option. Gently apply pressure to the connection tabs to disconnect the option as shown.

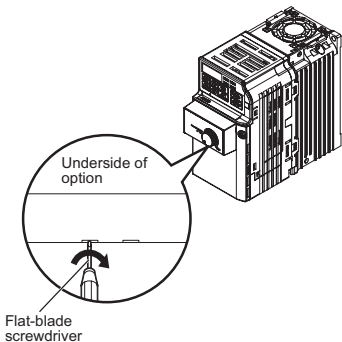

## 6 Operating Instructions

---

# 6 Operating Instructions

---

### ◆ Using the Option

1. Assign the frequency reference source for the drive to the potentiometer. Set drive parameter (b1-01=3).
2. Adjust the frequency reference by turning the potentiometer dial.

**NOTICE:** *Damage to equipment. Use caution when setting the frequency reference by adjusting the potentiometer dial slowly. Sudden changes to the frequency reference can damage the drive and connected machinery.*

## 7 Related Drive Parameters

### 7 Related Drive Parameters



No.	Name	Description	Default
b1-01	Frequency Reference Selection 1	Selects the frequency reference input source. 0: Operator - Digital preset speed d1-01 to d1-17. 1: Terminals - Analog input terminal A1. 2: MEMOBUS/Modbus communications 3: Option PCB	1
H3-13	Analog Input Filter Time Constant	Sets the primary delay filter time constant for terminal A1. Used for noise filtering.	0.03 s

## 8 Troubleshooting

# 8 Troubleshooting

Problems with the option interface may trigger an operator error. Refer to the J1000 Technical Manual for errors not listed in this manual.

### ◆ Fault

LED Operator Display		Fault Name
	oFA01	Option Unit Fault
Cause		Possible solution
The option unit is not properly connected to the drive		Turn the power off and reconnect the option unit
LED Operator Display		Fault Name
	oPE05	Run Command Selection Error
Cause		Possible solutions
Frequency reference is assigned to an option (b1-01 = 3) that is not connected to the drive		<ul style="list-style-type: none"><li>• Make sure that parameter b1-01 is set properly</li><li>• Reconnect the option unit to the drive</li></ul>



# 9 Option Specifications

### ◆ Drive Specification

Item	Specification
Model Number	AI-V3/J
Storage/ Installation Area	Indoors (an area free from oil mist and dust)
Ambient Temperature	-10 to +50°C
Humidity	95% RH or less with no condensation
Storage Temperature	-20 to +60°C allowed for short-term transport of the product
Altitude	1000 m or less

# 10 Yaskawa Locations

## 10 Yaskawa Locations

### **IRUMA BUSINESS CENTER (SOLUTION CENTER)**

480, Kamifujisawa, Iruma, Saitama 358-8555, Japan  
Phone 81-4-2962-5696 Fax 81-4-2962-6138

### **YASKAWA ELECTRIC AMERICA, INC.**

2121 Norman Drive South, Waukegan, IL 60085, U.S.A.  
Phone 1-847-887-7000 Fax 1-847-887-7370

### **YASKAWA ELÉTRICO DO BRASIL LTDA.**

Avenida Fagundes Filho, 620 São Paulo-SP CEP 04304-000, Brazil  
Phone 55-11-3585-1100 Fax 55-11-5581-8795

### **YASKAWA ELECTRIC EUROPE GmbH**

Am Kronberger Hang 2, 65824 Schwalbach, Germany  
Phone 49-6196-569-300 Fax 49-6196-569-312

### **YASKAWA ELECTRIC UK LTD.**

1 Hunt Hill Orchardton Woods Cumbernauld, G68 9LF, United Kingdom  
Phone 44-1236-735000 Fax 44-1236-458182

### **YASKAWA ELECTRIC KOREA CORPORATION**

7F, Doore Bldg. 24, Yeoido-dong, Youngdungpo-Ku, Seoul 150-877, Korea  
Phone 82-2-784-7844 Fax 82-2-784-8495

### **YASKAWA ELECTRIC (SINGAPORE) PTE. LTD.**

151 Lorong Chuan, #04-01, New Tech Park 556741, Singapore  
Phone 65-6282-3003 Fax 65-6289-3003

### **YASKAWA ELECTRIC (SHANGHAI) CO., LTD.**

No.18 Xizang Zhong Road. Room 1702-1707, Harbour Ring Plaza Shanghai 200001, China  
Phone 86-21-5385-2200 Fax 86-21-5385-3299

### **YASKAWA ELECTRIC (SHANGHAI) CO., LTD. BEIJING OFFICE**

Room 1011A, Tower W3 Oriental Plaza, No.1 East Chang An Ave.,  
Dong Cheng District, Beijing 100738, China  
Phone 86-10-8518-4086 Fax 86-10-8518-4082

### **YASKAWA ELECTRIC TAIWAN CORPORATION**

9F, 16, Nanking E. Rd., Sec. 3, Taipei, Taiwan  
Phone 886-2-2502-5003 Fax 886-2-2505-1280

(Address revision No.: 07-8-13)

## 11 Revision History

Document revision dates and revision numbers are provided on the bottom of the back cover.

MANUAL NO. TOBP C730600 34A

Published in Japan February 2008 08-2

└ Date of  
publication

└ Date of original  
publication

<b>Date of Publication</b>	<b>Rev. No.</b>	<b>Section</b>	<b>Revised Content</b>
February 2008	—	—	First edition

YASKAWA AC Drive-J1000 Option

# Potentiometer

## Technical Manual

---

Any inquiries related to the product can be directed to the address listed at chapter 10.



YASKAWA

In the event that the end user of this product is to be the military and said product is to be employed in any weapons systems or the manufacture thereof, the export will fall under the relevant regulations as stipulated in the Foreign Exchange and Foreign Trade Regulations. Therefore, be sure to follow all procedures and submit all relevant documentation according to any and all rules, regulations and laws that may apply.

Specifications are subject to change without notice for ongoing product modifications and improvements.

© 2008 YASKAWA ELECTRIC CORPORATION. All rights reserved.

MANUAL NO. TOBP C730600 34A

Published in Japan February 2008 08-2